

MAPMYINDIA

ICENAV 501

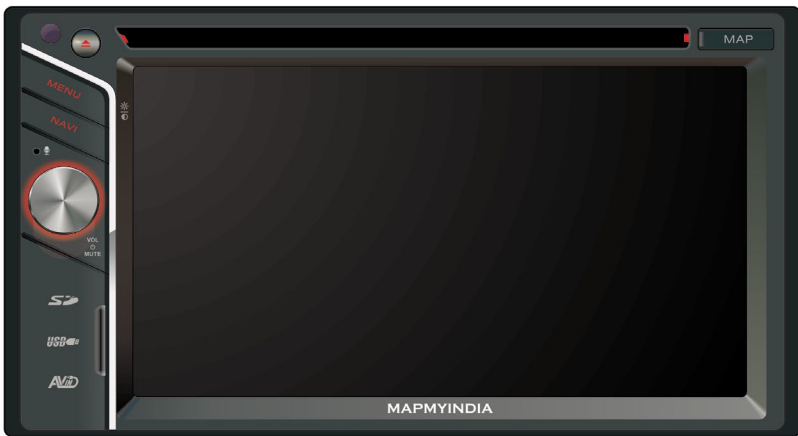

Operating Instructions

DVD/VCD/CD/MP3/MPEG4/SD/USB PLAYER WITH FM/AM TUNER
GPS & BLUETOOTH

Safety Precautions

Thank you for purchasing this product. Please read through these operating instructions so you will know how to operate your model properly. After you've finished reading the instructions, keep this manual in a safe place for future reference.

Only connect the unit to a 12-volt power supply with negative grounding.

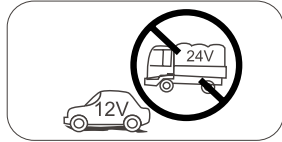

Never install this unit where the operation & condition for safe driving is impaired.

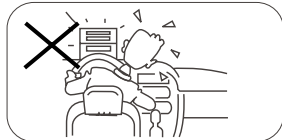

Never use the video display function in the front when driving to prevent the violation of laws & regulations and also to reduce the risk of traffic accident except for using rear view video camera.



Never expose this unit, amplifier, and speakers to moisture or water to prevent electric sparks or fire.

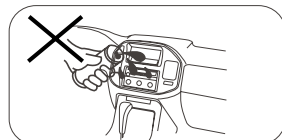

Please don't change the fuse on the power cord without professional guidance, using improper fuse may cause damage to this unit or even cause fire.

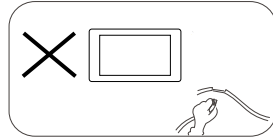

Please contact your nearest dealer if one of the following symptoms is experienced:

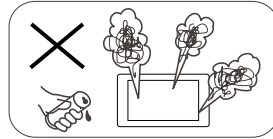

- Water or other objects enters the unit.
- There is smoke.
- Peculiar smell.

To ensure safe driving, please adjust the volume to a safe and comfortable level in case of emergency situations.

Safety Precautions

- Never disassemble or adjust the unit without any professional guidance. For details, please consult any professional car shop / dealer for inquiry.
- If the front panel or TFT monitor is dirty, please use a clean silicone cloth and neutral detergent to wipe off the spot. Using a rough cloth and non-neutral detergent such as alcohol for cleaning may result in scratching or decoloration to the monitor.
- If any abnormal behavior of the unit is found, please refer to trouble shooting guide of this manual. If no relevant information is found, please press the [RESET] button on the front panel to resume factory default.
- If you have parked the car in hot or cold weather for a long time, please wait until the temperature in the car becomes normal before operating the unit.
- Using the car heater in low temperature environment may result in moisture inside the unit, DO NOT use the unit in this situation. Eject the disc and wipe off the moisture on the disc. If the unit still doesn't work after a few hours, please contact the service center.
- Do not impact the LCD monitor which could cause damage.
- To prevent damage to the screen, avoid touching it with sharp objects.
- To provide a clear demonstration and an alternative for easy understanding to the operation of this unit, graphic illustrations are used. However, some illustrations are different from the actual images displayed on the screen.
- Operate the unit correctly according to this manual to prevent unnecessary problem. The guarantee won't be valid if the problem is caused by inappropriate operation.

Expanding Systems

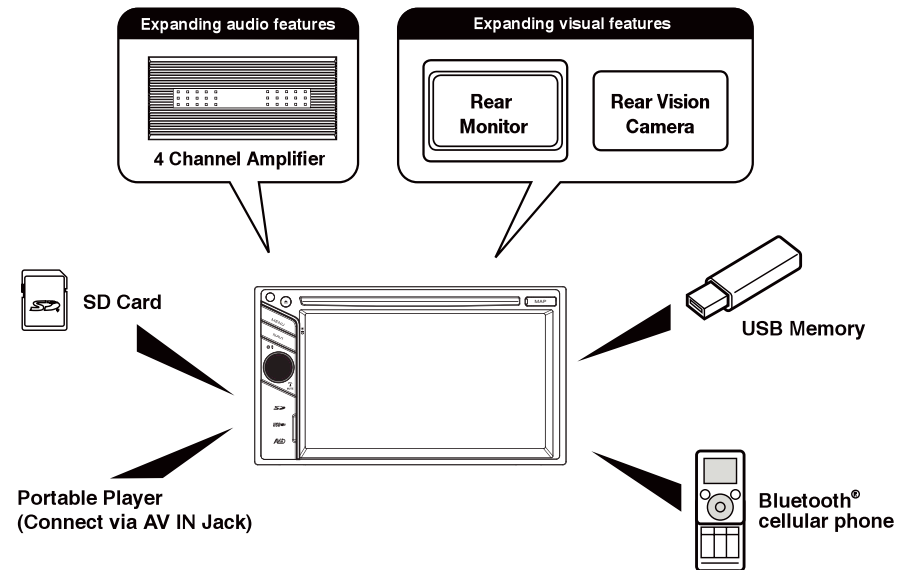

Note: The items listed outside of the frame are the commercial products generally sold.

Safety Precautions	1	Select Audio Mode.....	13
Before Using	4	Select Subtitle Language.....	13
Front Panel	4	Change View Angle	13
Remote Control.....	5	Video Setup	14
Notes on Remote Control Usage.....	6	Playback Information	14
Uninstall Battery.....	6	Direct Track Entry	14
Install Battery	6	Rotate Pictures	14
		Zoom.....	14
Basic Operations	7	Bluetooth Mode	15
Parking Brake Inhibit.....	7	Pair the Bluetooth-enabled Devices	15
Mute.....	7	Disconnect Bluetooth Device.....	15
Power On / Off.....	7	Make a Call.....	15
Audible Beep Confirmation.....	7	Answer an Incoming Call.....	15
Playing Source Selection.....	7	Adjust Bluetooth Settings.....	16
Volume Adjustment.....	7	Settings	17
EQ Menu.....	7	Display System.....	17
Select Preset Equalizer	8	Adjust General Settings.....	17
Adjust EQ Parameters.....	8	Calibration.....	17
Adjust Fader/Balance	8	Adjust Time Settings.....	17
Set Date /Time.....	9	Adjust Sound Settings	18
Radio Mode	10	Adjust Video Settings.....	18
Tuner TFT Display	10	Adjust Disc Rating	18
Select Radio as Playing Source	10	Adjust Volume Settings.....	19
Select One Radio Band.....	10	Adjust Reset Settings	19
Tune.....	10	Other Modes	20
Playback Mode	11	Listen to Other Devices	20
Load a Disc.....	11	Reset	20
Eject a Disc.....	11	GPS	20
Touch Screen Controls.....	11	Specifications	21
Preset Station	11	Troubleshooting	23
Local Seeking	11	Installation	24
EQ Selection.....	11	Wire Connections	25
Controlling Playback.....	12		
Connect a USB Device.....	12		
Remove a USB Device.....	12		
Insert/Remove a SD Card.....	12		
Play/Pause.....	12		
Previous/Next	12		
Search for a Folder.....	12		
Repeat	13		
Repeat A-B	13		
Shuffle (Random) Play.....	13		

Front Panel

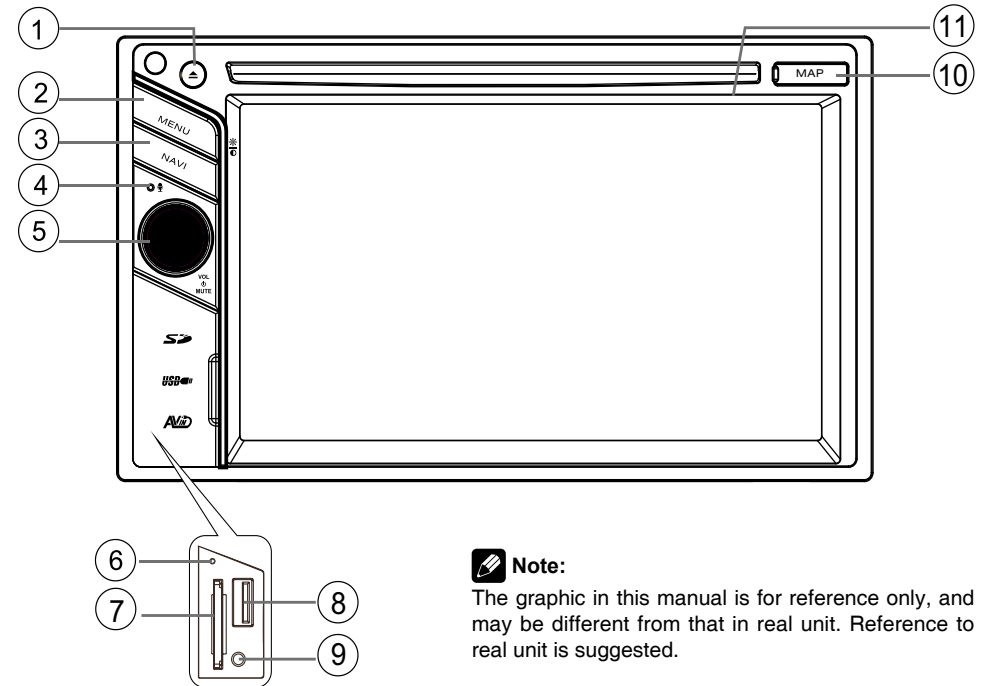

Note:

The graphic in this manual is for reference only, and may be different from that in real unit. Reference to real unit is suggested.

1. [Δ] Button: Eject disc
2. [MENU/ \ast] Button:
Press to switch between the main menu and current source.
Press and hold to enter brightness adjustment mode, then rotate the knob to adjust.
3. [NAVI] Button:
Press to switch to navigation mode.
4. Internal Microphone
Internal microphone for Bluetooth calls.
5. [VOL / \cup / MUTE] knob:
Press to turn the unit on. Press and hold again to turn the unit off.
Press to silence the audio volume.
Turn clockwise to increase the volume, and turn counter-clockwise to decrease the volume.
Rotate the knob adjust the screen brightness (press the [MENU/ \ast] button)

6. Reset Button
Press to reset system settings to factory default (except password and parental lock settings).
7. SD/SDHC card slot
Insert an SD card for playback of music/video/picture files.
8. USB Connector
Connect a USB device for playback of music/video/picture files.
9. A/V Input
Accepts a 3.5mm jack through which signals from various audio/video devices can be applied to the unit.
10. Map Slot
The Mini SD card is used for the Navigation Map only, not for music or other files. This may be used for firmware updates if required.
11. Disc slot

Before Using

Remote Control

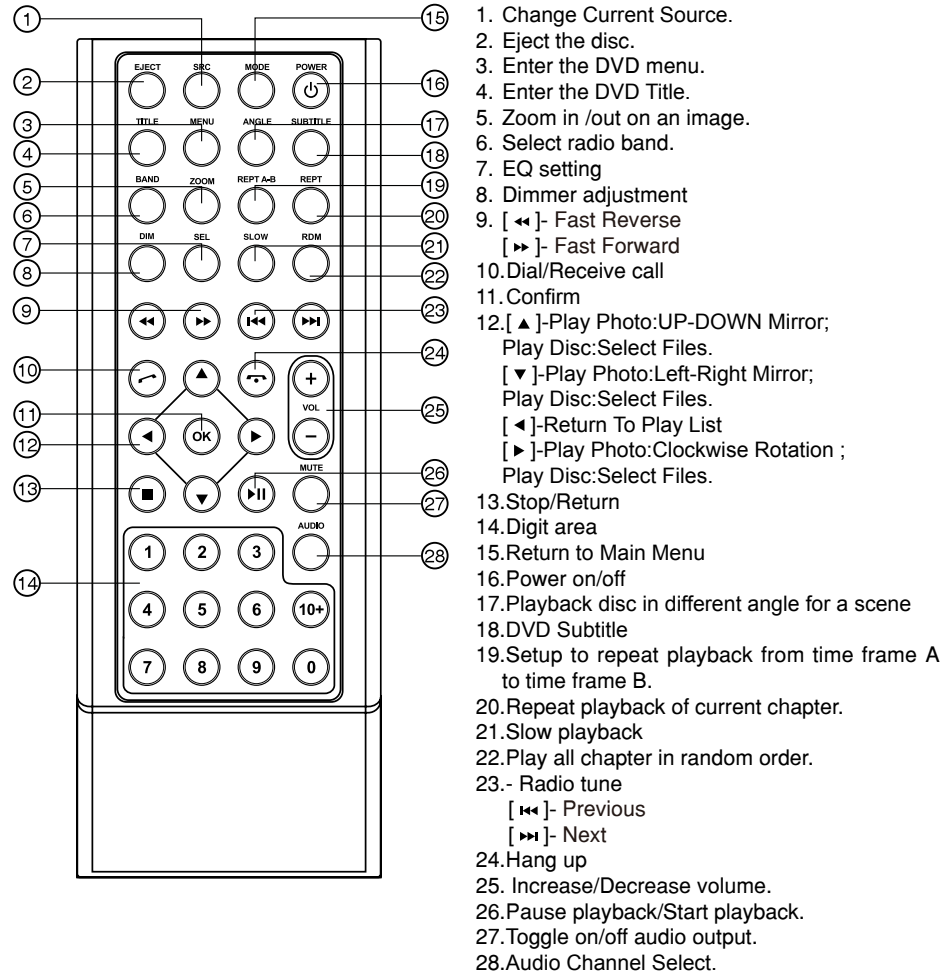

Before Using

Notes on Remote Control Usage

1. Aim the remote control at the remote sensor on the unit.
2. Replace the battery from the remote control or insert a battery insulator if the battery has not been used for a month or longer.
3. DO NOT store the remote control in direct sunlight or in high temperature environment, or it may not function properly.
4. The battery can work for 6 months under normal condition. If the remote control won't work, please change the battery.
5. Use "button shaped" lithium battery "CR2025"(3V) only.
6. DO NOT recharge, disassemble, heat or expose the battery in fire.
7. Insert the battery in proper direction according to the (+) and (-) poles.
8. Store the battery in a place where children cannot reach to avoid the risk of accident.

Uninstall Battery

Slide out the battery compartment tray at the bottom on the back of the remote control.

Install Battery

Use button-shaped lithium battery "CR2025 (3V)" only. Insert the battery to the battery tray with proper direction according to the (+) and (-) poles.

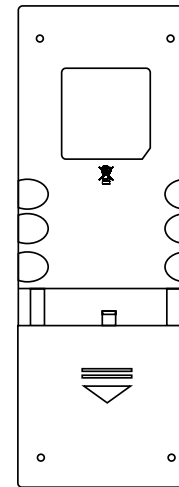

↓ PULL OUT

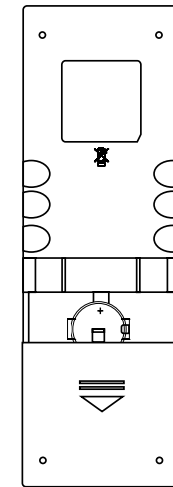

↑ PUSH IN

Parking Brake Inhibit

- When the "BRAKE" cable is connected to the brake switch, the display on the TFT monitor will display video only when the vehicle is applied.
- Parking brake function is overridden when the video source is set to REVERSE.
- When the parking brake inhibit is active, the front monitor displays "WARNING Do not watch video while driving!", preventing the driver from watching content while driving. Rear video screens are not affected.

Mute

Press [VOL / \cup / MUTE] knob or the [MUTE] button on remote control to mute the volume from the unit. Press again to restore the volume. [\blacktriangleleft] is displayed on the LCD. Adjusting the volume or using any of the audio setup features cancels the mute function.

Power On / Off

Press the [VOL / \cup / MUTE] knob on the unit (or the [POWER] button on the remote control) to turn the unit on. The current mode status appears in the LCD. Press and hold the [VOL / \cup / MUTE] knob to power off the unit.

Audible Beep Confirmation

An audible beep tone confirms each function selection. The Beep tone can be disabled through the Setup menu.

Playing Source Selection

Press the [MENU] button on the front panel or the [SRC] button on the remote to change between available playing sources. The playing mode is displayed on the screen.



- Date and Time display. Double click to switch to Clock mode.
- Function icons
- 1/2 or 2/2: Touch this page button to view the first or second page of on-screen buttons. You also can drag left or right on the blank area to switch the pages.
- Touch repeatedly to change wall papers.
- Touch for quick access to Equalizer level settings.

Volume Adjustment

To increase or decrease the volume level, turn the [VOL / \cup / MUTE] knob on the front panel or press the [VOL+] / [VOL-] button on the remote control. The volume ranges from "0" to "39". The LCD or TFT screen displays the volume level for 3 seconds.

EQ Menu

The Audio Control feature allows you to easily adjust your audio system to meet the acoustical characteristics of your vehicle, which vary depending on the type of vehicle and its measurements. Proper setting of the Fader and Balance boosts the effects of the cabin equalizer.

Select Preset Equalizer

- Enter the EQ setup mode
Touch the [] icon in the user interface and the EQ setup interface will display on the screen.
- Select EQ mode
 - [User] · [Rock]
 - [Flat] · [Class]
 - [Pop] · [Jazz]
 - [Techno] · [Optimal]



Adjust EQ Parameters

To adjust EQ parameters, touch and drag the parameters adjustment bar. Touch [\blacktriangle] / [\blacktriangledown] or drag [] to adjust the parameters.

- [User]: Set the desired audio effect.
- [BAS] bass range: -7 to +7
 - [MID] middle range: -7 to +7
 - [TRE] treble range: -7 to +7
 - [LPH] low pass filter range: 60, 80, 100, 200
 - [MPF] middle pass filter range: 0.5K, 1K, 1.5K, 2.5K
 - [HPF] high pass filter rang: 10K, 12.5K, 15K, 17.5K
- [LOUD: On/Off]: When listening to music at low volumes, this feature will selectively boost certain bass and treble frequencies.
- [RESET]: Cancel the equalizer function settings.

Adjust Fader/Balance

You can adjust front/back/left/right balance of the speaker and the subwoofer volume to get balanced listening effect according to the surroundings and your interest.

- Enter the EQ setup mode
Touch the [] icon in the user interface and the EQ setup interface will display on the screen.



- Adjust subwoofer volume
Touch [\blacktriangle] / [\blacktriangledown] or drag [] to adjust subwoofer volume from 0 to 38.
- Adjust fader / balance value
Touch [\blacktriangle] / [\blacktriangledown] / [\blacktriangleleft] / [\blacktriangleright] to adjust fader / balance value
 - [\blacktriangle]: Front speaker, fader range: 0 to 7.
 - [\blacktriangledown]: Rear speaker, fader range: 0 to 7.
 - [\blacktriangleleft]: Left speaker, balance range: 0 to 7.
 - [\blacktriangleright]: Right speaker, balance range: 0 to 7.

Note:

- The parameters of the EQ modes has been preset and you can not change them besides 'User'.
- The EQ mode will change to 'User' automatically when you adjust the frequency value under the modes besides 'User'.
- The value of Sub is independent of EQ mode and can be adjusted separately.

Basic Operations

Set Date /Time

1. Touch [].
2. Touch [Time].
The date/time setup menu is displayed.



• Set Date

1. Touch [Date].
2. Touch the date information on the screen .
A submenu is displayed.
3. Touch [▲] or [▼] to set year, month and day.

• Set Time Mode

1. Touch [Time Mmode].
2. Touch [12H] or [24H] to switch clock mode.

• Set Time

1. Touch [Time].
2. Touch the time on the screen, a submenu is displayed.
3. Touch [▲] or [▼] to set hour and minute.

• Set Desk Timer

1. Touch [Desk Timer].
2. Touch [Simulate Timer] or [Numeral Timer] .

• Set Time Zone

1. Touch [Time Zone].
2. A submenu will be displayed.
3. Touch to select the time zone you desire.
4. The time zone of the device default setting is " GMT +4:30".

• Set Power Off Timer

1. Touch [Power Off Timer].
2. Touch [On] or [Off] to select whether timer displays after power off.

Radio Mode

Tuner TFT Display



1. Touch to view the SOURCE MENU and select a new playback source
2. Distant signal broadcasting indicator
3. Current radio band indicator
4. Clock
5. Broadcaster information stored at the preset
6. Touch to view more on-screen buttons
7. Touch to seek backward
8. Scan preset stations
9. Touch to seek forward
10. Touch to change between AM/FM bands
11. Current radio information
12. Current band preset radio stations
13. Touch to change between Local and Distance
14. Enter frequency directly
15. Touch for quick access to Equalizer level settings

Select Radio as Playing Source





Open the Source Menu and then touch [Radio].

Select One Radio Band

Press the [BAND] button on remote control or touch the [] icon on the user interface to select one radio band among FM1, FM2, FM3, AM1 and AM2.

Tune

Auto Tuning

Press the [] / [] button on the remote control briefly or hold [] / [] icon on the user interface more than 1 second to seek a higher / lower station.

To stop searching, repeat the operation above or press other keys having radio functions.



Note:

When a station is received, searching stops and the station is played.

Manual Tuning

Method 1:

During manual tuning, the frequency will be changed in steps.

Press the [▲] or [▼] button on remote control or touch the [] / [] icon on the user interface to tune in a higher / lower station.

Method 2:

1. Touch the numeric keypad icon [].
Numeric keyboard is displayed, touch number to input frequency.

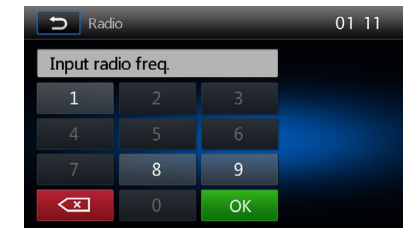

2. Touch [] to delete the input number step by step.
3. Touch [OK] to enter.

Preset Station

The unit has 5 bands, such as FM1, FM2, FM3, AM1, AM2, and each band can store 6 stations; hence the unit can store 30 stations in total.

Intro/Scan

Press the [🔍] icon to intro. Each stored station will play for 5 seconds automatically. Hold down the [🔍] icon to scan. Only stations with sufficient signal strength will be detected and stored in the memory. After scanning, P1 will play automatically.

Manual Store

1. Tune to a station.
2. Touch [••••] to display the 2nd menu.
3. Touch [⏴].
4. Touch one of the channels P1 to P6 to save the select band.



Tune to a Preset Station

1. Touch [Radio].
2. Select a band (if needed).
3. Touch one of the preset channels (P1 to P6) on the screen.

Local Seeking

Touch the [📶] icon and choose the Radio Local or Distance. When the [📶] icon turns bright, only stations with sufficient signal strength will be detected.

EQ Selection

Press the [📊] icon and enter the EQ setup.

Load a Disc

You can play video, audio or images stored on the following discs:

- DVD Video, DVD-R, DVD-RW
- VCD
- Audio CD, CD-R, CD-RW

Note:

Ensure that the disc contains playable content.

Eject a Disc

Press the [⏴] button on the front panel or remote control to eject the disc. When the disc is ejected, the unit switches to the previous source.

Touch Screen Controls

The touch key areas for DVD playback are outlined below:

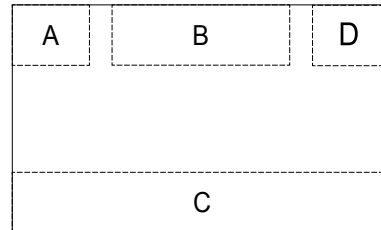

- A: Return to the main menu
- B: Play the video and display playback information
- C: Display onscreen control menu
- D: Time display

Controlling Playback

To access the on-screen controls, touch the screen except upper left corner, and touch again to cancel display. Touch [••••] to view all function icons.



Connect a USB Device

1. Open the USB cover.
2. Insert the USB device into the USB slot. Play starts automatically.

Remove a USB Device

1. Select other source on the main menu.
2. Remove the USB device.

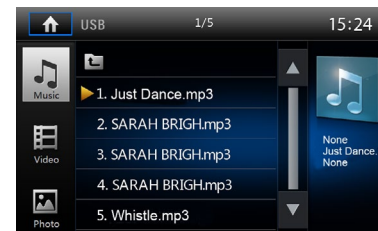

Insert/Remove a SD Card

- Insert
 1. Open SD card cover.
 2. Insert the SD card into the SD card slot. Play starts automatically.
- Remove
 1. Select other source on the main menu.

2. Press the card unit you hear a click sound.
3. Remove the SD card.

Play/Pause

1. Once a disc, USB is inserted, play starts automatically. For DVD movie, if a menu appears, press [▶] to start play.
2. To pause, touch [⏸]. To resume play, touch [▶].
3. Skip to previous / next track / chapter, press [⏮] / [⏭] icon.



Previous/Next

Touch [⏮] / [⏭] icon on the screen to skip to previous / next track / chapter.

Search for a Folder

For Video Files

1. Touch [📁] to display all available video folders.
2. Touch a folder, then touch the desired file.
3. Touch the file again to start play.

For Audio Files

1. Touch [🎵] to display all available audio folders.
2. Touch a folder, then touch the desired file.
3. Touch the file again to start play.





Playback Mode



For Picture Files

1. Touch [] to display all available picture folders
2. Touch a folder, then touch the desired file.
3. Touch the file again to start play.





Repeat

For DVD/VCD movie disc:

1. Touch bottom half of the screen to display menu on the screen, if necessary.
2. Touch [.....] to display the 2nd menu.
3. Touch [] repeatedly to select:
 - DVD
[] Repeat chapter: Play the current chapter repeatedly.
 - [] Repeat title: Play all chapters in the title repeatedly.
 - [] Repeat off: Play all in the all repeatedly.Repeat off: Cancel repeat play.

- VCD
[] Repeat single: Play the current single repeatedly.
 - [] Repeat all: Play all in the all repeatedly.
- Repeat off: Cancel repeat play.

For CD/MP3/WMA files:

1. Touch anywhere except the upper left corner to display menu on the screen, if necessary.
2. Touch [] repeatedly:
 - [] Repeat single: Play the current single repeatedly.
 - [] Repeat all: Play all in the all repeatedly.
 - [] Repeat folder: Play all in the current folder.
 - [] Repeat off: Cancel repeat play.

Repeat A-B

You can repeat a specific of video file (repeat A-B).

1. Touch the screen to display control menu, if necessary.
2. Touch [.....] to display the 2nd menu, if necessary.
3. Touch [A-B] repeatedly to mark:

- Repeat A-: the start of the section to repeat.
Repeat A-B: the end of the section to repeat.
The selected section plays repeatedly.
4. To exit A-B repeat mode, touch A-B repeatedly, [Repeat A-B off] is displayed.

Shuffle (Random) Play

You can play audio tracks/files in random order.

1. Touch the screen to display control menu, if necessary.
2. Touch [.....] to display the 2nd menu, if necessary.
3. Touch [] on the screen remote control repeatedly to turn random play on or off.

Select Audio Mode

When you play VCDs, you can select an audio mode (R/L/Stereo).

1. During play, touch bottom half of the screen to display menu on the screen, if necessary.
2. Touch [.....] to display the 2nd menu.
Touch [] repeatedly until the audio mode is selected.

Select Subtitle Language

For DVD or Divx discs that contain two or more subtitle languages.

1. During play, touch the screen to display menu on the screen, if necessary.
2. Touch [.....] to display the 2nd menu.
3. Touch [] repeatedly to select a language.
The selected language is displayed.

Change View Angle

Some DVDs contain alternate scenes, such as scenes recorded from different camera angles.



For these DVD disc, you can select from the available alternate scenes.

Press [Angle] repeatedly on the remote control.

The view angle is changed.

Playback Mode

Video Setup

Touch [] to access video setup mode, touch [] or [] to set the desired effect.



You may set the brightness, contrast, and saturation of the video output from 0 to 16.

Playback Information

Touch the screen when playing back DVD and VCD discs and the playback information will be displayed on the top area of the TFT.

For DVD

1. Disc type.
2. DVD Title information. "1/8" indicates that this DVD has 8 titles and the title playing back now is the first title.
3. DVD Chapter information. "5/12" indicates that current title has 12 chapters and the chapter playing back now is the fifth chapter.

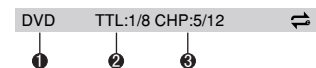

For VCD

1. Disc type.
2. VCD Track information. "1/8" indicates that this VCD has 8 tracks and the track playing back now is the first title.



Elapsed Time

1. Elapsed time of the current track.
2. Total time of the current track.



Direct Track Entry

To select a track directly, touch the [] icon on screen control to display the direct entry menu. Enter the desired track using the on-screen number pad. Press [OK] to the selected track.

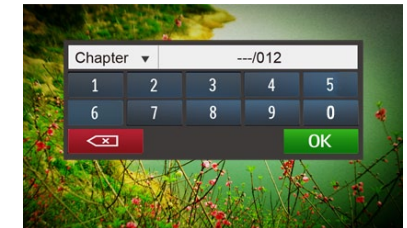

Rotate Pictures

1. When you view pictures, touch the screen to display menu on the screen, if necessary.
2. Touch [.....] to display the 2nd menu.
3. Touch [] repeatedly to rotate the picture.

Zoom

You can zoom in pictures for a close view.

1. When you view pictures, touch the screen to display menu on the screen, if necessary.
2. Touch [.....] to display the 2nd menu.
3. Touch [] repeatedly to zoom in or out the picture.

Bluetooth Mode

You can make or receive phone calls with Bluetooth-enabled phones through the unit. You can also listen to music from a Bluetooth-enabled device.

Pair the Bluetooth-enabled Devices

To connect your Bluetooth device to the unit, you need to pair the device to the unit. Pairing needs only to be done once. You can pair up to five devices. You also can search for Bluetooth devices by mobile phone.



1. Turn on the Bluetooth function on the device.
2. Touch [+] to search for Bluetooth device with the device.
3. Select the Bluetooth device ID in the pairing list.
4. Touch [Link].
5. Enter default password "0000".

Note:

- The operational range between this unit and a Bluetooth device is approximately 5 meters.
- Before you connect a Bluetooth device to this unit, familiarize yourself with the Bluetooth capabilities of the device.
- Compatibility with all Bluetooth device is not guaranteed.
- Any obstacle between this unit and a Bluetooth device can reduce the operational range.
- Keep this unit away from any other electronic device that may cause interference.

Disconnect Bluetooth Device

To disconnect one device, touch [].

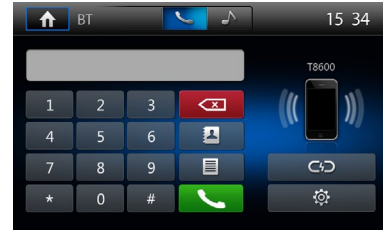

Note:

- The device will also be disconnected when the device is moved beyond the operational range.
- If you want to reconnect the device to the unit, place it within the operational range.
- If you do not want to reconnect the device to the unit automatically, touch [], then set [Auto Connect] to [Off]. For details, see the "Adjust Bluetooth Settings" section.

Make a Call

1. Select Bluetooth function in the home menu.
2. Pair the phone with the unit.
3. Search for phone number from the following list:
 - []: Phone Book
 - []: Call Log
 - [Missed calls]
 - [Received calls]
 - [Dialed calls]

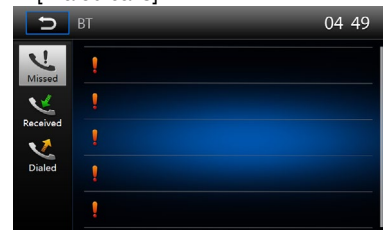

Or touch the number pad directly.

Answer an Incoming Call

By default, all incoming calls are received automatically.

1. If there is an incoming call, the screen will appear "Incoming".

Bluetooth Mode



2. You may touch the screen to select [Hang up] or [Answer]. Speak into the Bluetooth microphone.



- []: Touch to mute the microphone audio from the unit. Touch the icon again to restore the microphone audio from the unit.
- []: Touch to access the direct dial screen.
- []: Touch to transfer a call back to the mobile phone.

Note: You can select to receive calls manually by set [Auto Answer] to [Off] status.

Adjust Bluetooth Settings

1. In Bluetooth menu, touch []. The option menu is displayed.



2. Touch on the selected option to change the setting.
 - [BT]: To turn on or off "Bluetooth" function.
 - [Auto Connect]: To turn on or off "Auto connect" function.

- [Auto Answer]: To turn on or off "Auto answer" function.
- [Pair Password]: To set pairing code.
- [Phone Book]: To synchronize phone book, touch [Download] on the sub-menu popped out. Phonebook sync may take several minutes to load on initial setup.

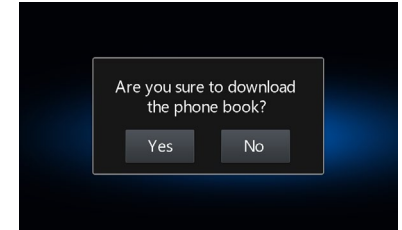

Music Mode

A2DP

A2DP is short for Advanced Audio Distribution Profile. The mobile phones supporting this function can transmit stereo audio, whereas the ones not supporting this function can transmit mono audio only.

AVRCP

AVRCP is short for Audio/Video Remote Control Profile. The mobile phones supporting this function can control the playback of a Bluetooth audio player.

In the mode of the music player working, if you want to make a phone call, you can press the number keys on the mobile phone. At the same time the music player will stop. The TFT screen will display "Calling", after the call received, the voice will be transferred to the unit. When the call ends, the screen will display music playing menu. If there is an incoming phone call, the music player will stop, and the screen will display "Incoming Call". When the call ends, the screen display music playing menu.

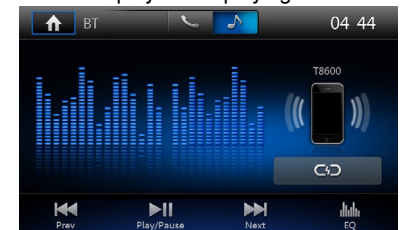

Settings

Display System

1. Touch the upper left corner to display main menu.
2. Touch [Settings].
The settings menu is displayed.
3. Touch the upper left corner of the screen to exit.

Adjust General Settings

1. Touch [General], if necessary.
2. Touch to select a setting.
3. Touch on the option to display/select an option.

General settings	Options	Description
Language	Select on-screen display language.	
Radio Area	Europe	Select one that matches your location.
	America	
	America4	
	East Europe	
	Australia	
	China	
Beep	On	Turn on the beep sound. Each time you press a button, the unit beeps.
	Off	Turn off the beep sound.
Calibration	Yes	Calibrate the touch screen.
Wallpaper	Ok	You can select a wall paper.
Gps path setup.		
Key Color	Adjust	You can select the color of the key.
Mic Setup	Internal	Internal microphone for Bluetooth calls.
	External	External microphone for Bluetooth calls.

Calibration

When the touch operation is not sensitive or valid, you should calibrate the touch screen through calibration setting function. Adjust the response positions of the touch panel as followings:

1. Press the [Calibration] option on the setup menu to enter.
2. Touch [Start] to enter.
3. Press and hold the center of [+] for 2 seconds, the [+] will move automatically.
4. Aim at center of [+], follow the path as shown of the figure, after steps from 1 to 5, the system will exit calibrating automatically.

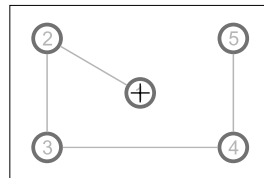

Adjust Time Settings

1. Touch [Time].
2. Touch an option repeatedly to select.

Time settings	Options	Description
Date	Year/ Month/Day	Touch [▲] or [▼] to set year, month and day.
Time Mode	12H/24H	Touch [12H] or [24H] to switch time mode.
Time	Touch [▲] or [▼]	to set hour and minute.
Desk Timer		Touch to select [Simulate Timer] or [Numeral Timer].
Time Zone		Touch to select the time zone you desire.
Power Off Time	On/Off	Touch to select whether the time displays after power off.

Settings

Adjust Sound Settings

1. Touch [Sound].
2. Touch an option repeatedly to select.

Sound settings	Options	Description
Sub Woofer Filter	Flat	Touch to select a crossover frequency.
	80Hz	
	120Hz	
	160Hz	
Loud	On/Off	When listening to music at low volumes, this feature will selectively boost certain bass and treble frequencies.
Reverse Mute	On/Off	Turn on/off the reverse sound.

Adjust Video Settings

1. Touch [Video].
2. Touch an option repeatedly to select.

Video settings	Options	Description
Backview Mirror	Mirror	When you drive in reverse, the rear view is displayed in mirror.
	Normal	When you drive in reverse, the rear view displayed in normally.
Brightness Setup	Night	Touch to select the desired brightness setting.
	Dark	
	Normal	
	Brightness	
Parking	On / Off	Enable video / disable video.

When in Park "On" mode, the screen will display "WARNING" [if you play the video disc]. The above warning screen will prevent the driver watching images.

Adjust Disc Rating

1. Touch [Disc].
2. Touch an option repeatedly to select.

DVD rating	Options	Description
Set password		Set password to restrict the play of discs. The default password is 0000.
Rating level	Kid safe	Acceptable for children.
	G	Acceptable for general viewers.
	PG	Parental guidance suggested.
	PG-13	Unsuitable for children under age 13.
	PG-R	Recommend parents to restrict children under 17 to view.
	R	Restricted recommend parents to guide children under 17 to view.
	NC-17	Unsuitable for children under age 17.
Adult	Acceptable for adults only.	
DVD Audio		Select DVD audio language. Options available depend on DVD disc.
DVD Subtitle		Select DVD subtitle language. Options available depend on DVD disc.
DVD Menu		Select DVD menu language. Options available depend on DVD disc.
Aspect Ratio		Touch to select display ratio: [4:3 PS], [4:3 LB], or [16:9].

Adjust Volume Settings

You can set different volume for different modes.

1. Touch [Volume].
The volume setting sub-menu is displayed.
2. Touch on a source.
 - [Media]
 - [Radio]
 - [Bluetooth]
 - [AV-IN1]
 - [AV-IN2]
3. Touch [▲] or [▼] to assign value: 0 to 12.
When switching to the source, the volume increases automatically.

Adjust Reset Settings

1. Touch [Reset].
2. Touch an option repeatedly to select.

Language settings	Description
Reset Factory	
Reset Volume	Touch to restore to default settings.
Reset Video	

Listen to Other Devices

You can connect an external audio/video device to the unit.

1. Connect the external device with the supplied AV cable.
2. Touch the upper left corner to display the main menu.
3. Touch [AV-IN 2] = Rear input
[AV-IN 1] = Rear input

Reset

When the unit hangs up, you can reset it. Press [RESET] with a ball-point pen or similar tool.

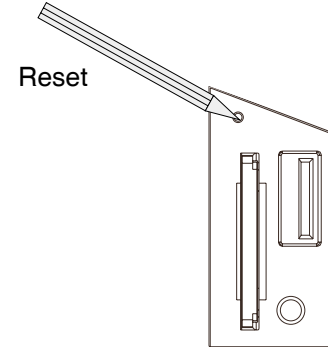

Note:

When the unit has been reset, all the settings will return to default settings.

Steering Wheel Control Programming

1. Touch the upper left corner to display home menu.
2. Touch [SWC], the SWC menu will display.
3. Press each individual steering wheel control button for each corresponding function.
4. Once the final steering wheel control button is programmed, the functions are saved and the programming will end.
5. Touch [Reset] to reset the programming.

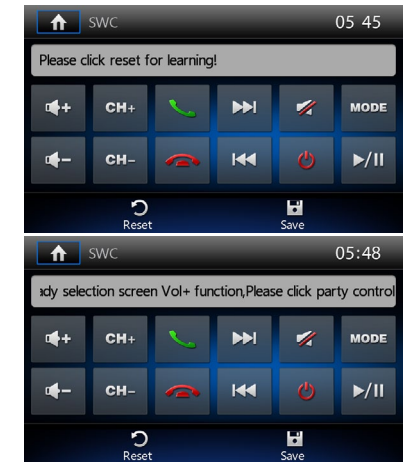

GPS

1. Touch the upper left corner to display home menu.
2. Touch [Navi], the navigation menu will display.
3. Refer to the map manual to operate the navigation tool.

For the GPS system is independent and complicated, for more details, please refer to "Navigation manual" (Not included in this manual) .

Specifications

General

Reference Supply Voltage.....	12V(DC)
Operating Voltage Range.....	10.5 - 15.8V(DC)
Max Operating Current.....	15A
Maximum Output Power.....	45W x 4 channels
RMS Power Output.....	25W x 4 channels
Grounding System.....	Car Battery Negative Pole
Dimensions(WXHXD).....	178. 0x101. 5x174. 6mm
Weight(main unit).....	1.82kg

FM

Signal Noise Ratio.....	≥55dB
Residual Noise Sensitivity (S/N=30dB).....	18dBμV
Frequency Response (±3dB).....	20Hz~12.5KHz
Station Seeking Level.....	20~28dBμV
Distortion.....	≤1.0%
Stereo Separation (1KHz).....	≥25dB
Antenna Impedance.....	75Ω

AM

Residual Noise Sensitivity (S/N=20dB).....	30dBμV
Selectivity (±9KHz).....	≥50dB

LCD

Screen size.....	6.2 inches
Display resolution.....	800X480dots
Contrast ratio.....	400 ²

DVD Player

Signal / Noise Ratio.....	.80dB
Dynamic Range.....	.80dB
Distortion (line out).....	≤0.1%
Frequency Response (±3dB).....	20Hz~20KHz
Load Impedance.....	4Ω

AUX IN

Distortion.....	≤0.5%
Frequency Response (±3dB).....	20Hz~20KHz
Audio Input Level.....	0.5Vrms

Audio

Audio Output Impedance.....	100Ω
Audio Output Level.....	1Vrms(Max)

Video

Normal Video Input Level (CVBS).....	1.0±0.2V
Video Input Impedance.....	75Ω
Video Output Impedance.....	75Ω
Video Output Level.....	1.0±0.2V

Environment

Operating Temperature.....	-10°C ~ +60°C
Storing Temperature.....	-20°C ~ +70°C
Operating Humidity.....	45%~80%RH
Storing Humidity.....	30%~90%RH

Note:

When the unit is operated to extremes, such as with maximum power output for a long time, or the temperature is over 70°C, it will enter heat protection mode, the volume will be reduced automatically. This is normal.

Specifications

Supported Formats:

- USB or memory file format: FAT32
- Mp3 bit rate(date rate): 32-320 Kbps and variable bit rate
- WMA v9 or earlier
- Directory nesting up to a maximum of 8 levels
- Number of albums/folders: maximum 99
- Number of tracks/titles: maximum 999
- ID3 tag v2.0 or later
- File name in Unicode UTF8(maximum length:128 bytes)

Unsupported Formates:

- Empty albums:an empty album is an album that does not contain MP3/WMA files,and is not be shown in the display.
- Unsupported file formats are skipped.For example,Word documents(.doc) or Mp3 files with extension.dlf are ignored and not played.
- AAC,WMAV,PCM audio files
- DRM protected WMA files(.wav,.m4a,.m4p,.mp4,.aac)
- WMA files in Lossless format

Supported MP3 Disc Format:

- ISO9660,Joliet
- Maximum title number: 512(depending on file name length)
- Maximum album number: 255
- Supported sampling frequencies: 32kHz,44.1kHz,48kHz
- Supported Bit-rates: 32-320Kbps and variable bit rate

Supported Video Formats:

- DVD
- MP4
- Xvid

Region Code

According to DVD sale region, the whole world is divided into six regions. A DVD disc can be played back only when its region code is compatible with that of the player in use.

Region 1: USA, Canada, East Pacific Ocean Islands;

Region 2: Japan, West Europe, North Europe, Egypt, South Africa, Middle East;

Region 3: Taiwan of China, Hong Kong of China, South Korea, Thailand, Indonesia, South East Asia;

Region 4: Australia, New Zealand, Mid & south America, South Pacific Ocean Islands/Oceania;

Region 5: Russia, Mongolia, India, Middle Asia, East Europe, North Korea, North Africa, North West Asia;

Region 6: Chinese Mainland.

Cautions when using Discs

1. DO NOT use irregular shaped disc.
2. Disc Cleaning
Use a dry, soft cloth to wipe the disc from center to edge, only neutral detergent can be used.
3. When playing a new disc
New disc may have some rough spots around the inner and outer edges. If such a disc is used, remove these rough spots with a pencil or ball-point pen, etc.

Troubleshooting

What appears to be trouble is not always serious. Please check the following points before calling a service center.

Problem	Cause	Corrective action
General		
Unit can not power on	Unit fuse blown.	Install new fuse with correct rating.
	Car battery fuse blown.	Install new fuse with correct rating.
	Illegal operation	Reset the unit.
Remote control does not work	Battery depleted.	Change the battery.
	Battery installed incorrectly.	Install the battery correctly.
No/low audio output	Improper audio output connection.	Check wiring and correct.
	Volume set too low.	Increase volume level.
	Speakers damaged.	Replace speakers.
	Heavily biased volume balance.	Adjust the channel balance to center position.
	Speaker wiring is in contact with metal part of car.	Insulate all speaker wiring connections.
Poor sound quality or distortion	Pirated disc is in use.	Use original disc.
	Speaker power rating does not match unit.	Replace speakers.
	Wrong connections.	Check wiring and correct.
	Speaker is shorted.	Check wiring and correct.
Unit resets itself when engine is off	Incorrect connection between ACC and BATT.	Check wiring and correct.
TFT monitor		
Warning information is shown at all times	Parking break wiring is not correct.	Check wiring and correct.
Flashing image or interference appears on screen	The color system of DVD disc does not match the monitor.	Adjust the color system of the DVD disc playing back or the monitor in use.
	Pirated disc is in use.	Use original disc.
	Video cable damaged.	Replace cables.
	Improper video signal connections.	Check wiring and correct.
Disc playback		
Cannot insert disc	A disc is already inside the unit.	Eject current disc and insert new one.
Disc does not play back	Disc is warped or scratched.	Use disc in good condition.
	Disc is dirty or wet.	Clean disc with soft cloth.
	Incompatible disc is used.	Use compatible disc.
	Disc is inserted upside down.	Insert disc with label side up.
	Disc region code is not compatible with unit.	Use disc with proper region code.
PBC cannot be used during VCD playback	PBC is not available on the disc.	Use disc with PBC available.
Repeat or search function is invalid during VCD playback	PBC is on.	Turn PBC off.
Error messages		
No disc	Disc is dirty.	Clean disc with soft cloth.
	Disc is upside down.	Insert disc with label side up.
	No disc inside.	Insert disc.
Bad disc	Disc is dirty.	Clean disc with soft cloth.
	Disc is upside down.	Insert disc with label side up.
Unknown disc	Disc format is not compatible with this unit.	Use disc with compatible format.
Region Error	DVD region code is not compatible with this unit.	Use disc with compatible region code.

Installation

Disconnecting the Battery

To prevent a short circuit, be sure to turn off the ignition and remove the negative (-) battery cable prior to installation.

Note:

If the unit is to be installed in a car equipped with an on-board drive or navigation computer, do not disconnect the battery cable. If the cable is disconnected, the computer memory may be lost. Under these conditions, use extra caution during installation to avoid causing a short circuit.

Remove Transport Screws

WARNING! Remove these two transport screws before installation. Otherwise, the DVD player will not work.

Replacing the Fuse

When replacing the fuse, use a new 15A replacement fuse. Using a fuse with an improper rating could damage the unit and cause a fire.

Wire Connections

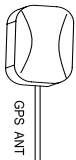
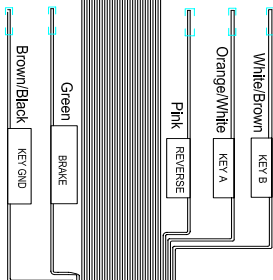
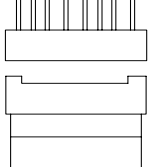
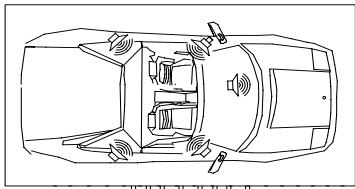

GPS ANT

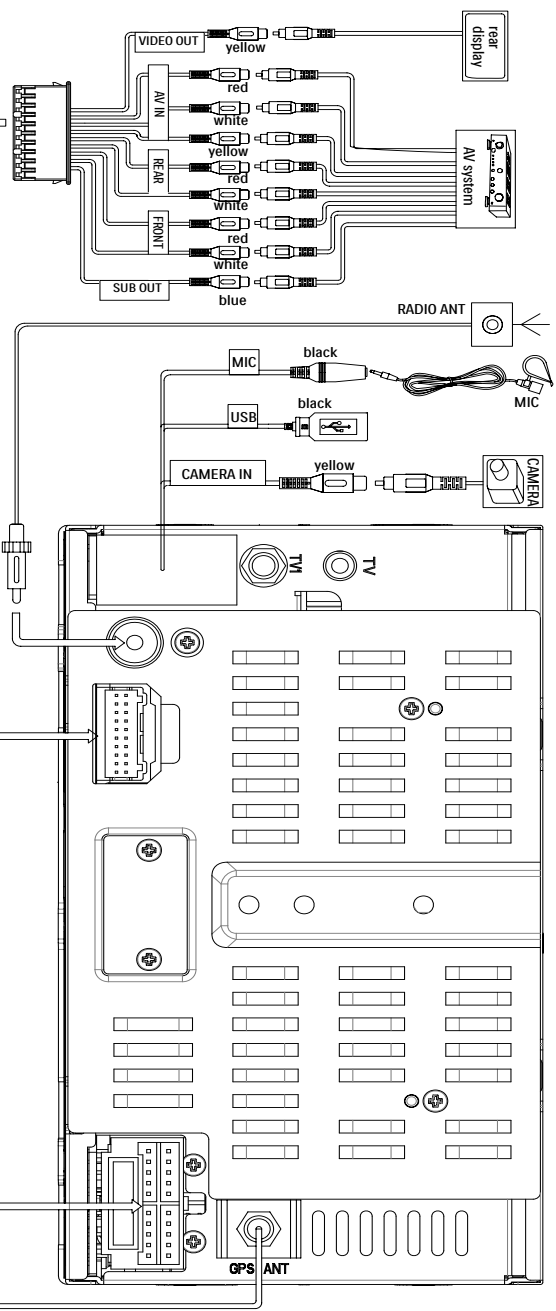

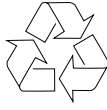

**CLASS 1
LASER PRODUCT**

P/N:127075005483